



SPIRAL CUTTERHEAD

Operating Instructions and Parts Manual



Qingdao Jiakemu Machinery Manufacture CO.,LTD

Address : West Of No.2 Tianshan Road Tongji Sub-district

Jimo-city ShanDong Province China,266200

Tel. +86 0532 66095060 Fax. +86 0532 82529139

Email : jiakemu@163.com Website: www.jiakemu.com



Description

This type of spiral cutterhead is designed with a true shear cut. The carbide knives sit at an angle along the helical grooves. It reduces the tear-out of your work, makes smaller chips and less noise than any other type of cutterheads. If one knife edge is dull or nicked, just turn it to another edge in seconds and the cutterhead works perfectly as a new one again. This greatly reduces your down time. Replace the inserts only when four edges are dull. You don't need to replace all the knives as you have to do with the conventional single straight knife. It pays you back in a very short time.

Unpacking

After taking out the cutterhead from its craton or crate, put it on supporting blocks such as V blocks. Remove the wrapping materials with a scissor or knife. inspect carefully for any damage that may have occurred during transit. Check for loose, missing, or damaged parts.

Pay special attention during unpacking and never put the cutterhead on ground or floor without protection to the cutterhead. Direct contact of the carbide inserts to hard materials, floor or ground may damage the edges of the inserts.

Check for shipping damage. If damage has occurred a claim must be filed with carrier. Check for completeness. Immediately report missing parts to dealer.



Fig 1- 15" spirial cutterhead

Part Lists

Carbide insert size: 15x15x2.5mm R150mm

- | | | |
|---------|---|-----------------------------------|
| Screw : | <input checked="" type="checkbox"/> 10#-32TPI | <input type="checkbox"/> M6 |
| Wrench: | <input checked="" type="checkbox"/> Torx T25 | <input type="checkbox"/> Torx T20 |

Use only genuine Cater Tools authorized replacement blades, knives, inserts and parts.

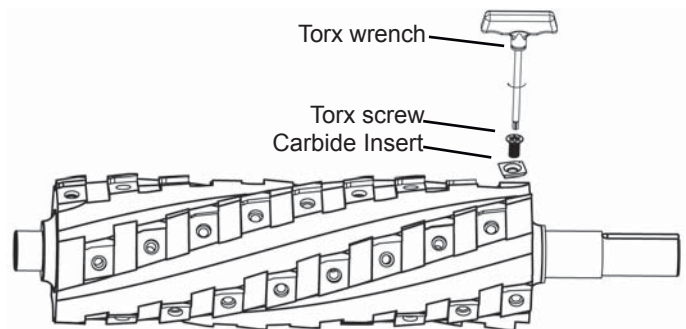

Fig 2- Part List

General Safety Information

⚠WARNING For your own safety and the safety of others, read through this owner's manual carefully before operating tool.
⚠CAUTION Protect yourself and others by observing all safety information, warnings, and cautions. Always follow proper operating procedures as defined in this manual, even if you are familiar with use of this tool or similar tools. Remember that being careless for even a fraction of a second can result in severe personal injury and/or damage to product or property. Please retain instructions for future reference.

Cater Tools disclaims any liability for tools that have been changed, modified or not used properly. Cater Tools reserves the right to make at any time, without prior notice, proper alterations to parts, components, the tool bodies we may deem necessary for any reason whatsoever.

Safety, however, is ultimately the responsibility of the individual tool operator. The operator must exercise common sense and caution to use the tools safely. Before using this tools, familiarize with the following safety rules.

1. If you are not properly trained in the use of a tool, do not use it until you have obtained proper training.
2. Know the limitations and hazards associated with this tool.
3. Do not wear gloves. Remove ties, rings, watch and other jewelry, loose outer clothing before you use this tool.
4. Confine long hair.
5. Wear an approved safety shield, goggles, or glasses to protect your eyes. Where the noise exceeds the level of exposure, use hearing protective device such as ear plugs.
6. Follow the safely rules as requested by your machine manufacturer.
7. Keep your machine guards in place before you use this tool. If any guards are removed for maintenance, DO NOT USE this tool until the guards are reinstalled.
8. Never start your work while your workpiece is in contact with the blades or knives.
9. Make sure the tool is running in the proper direction. The knives should be turning toward the infeed of your work
10. Always use push blocks when operating manually fed machines. Keep yourself at balanced stance all the time.
11. Disconnect all power sources for your machine before you perform any adjustment, maintenace or change knives.
12. Pay undivided attention to your work. Looking around, carrying on a conversation can result in serious injuriies.
13. This tool is designed for cutting wood, plastic, rubber, XPS board, EPS board etc. Do not use it to cut any kind of metal substance. Otherwise Cater Tools disclaims any warranty and holds itself harmless for any injury or damage which may result from that use.
14. Use only genuine Cater Tools authorized replacement blades, knives, inserts and parts.

Insert Installation

1. If the cutterhead is on your machine, disconnect it, not just stop the machine.
2. Blow off or remove any chip or sawdust from the screw head(s).
3. Turn the screw drive wrench counterclockwise, remove the screw from the cutterhead, lubricate the screw threads with a light machine oil.
4. Brush or blow off any chip or dust from the seat. The seats need to be as clean as possible so as to avoid insert breakage or cutting ridges.
5. Rotate the insert 90 degree clockwise or put a new carbide insert at the "start" position as per Fig 3. Put the screw in the hole, turn the screw down with your finger.
6. Press down the carbide insert lightly against the seat bottom with your finger, turn the screw drive wrench clockwise, tighten the screw, the carbide insert can be pushed toward the seat back.
7. Visually inspect and make sure that the insert is in place and there is no void between the insert and the tool body as Fig 4 shows.
8. Torque the screws with an optional Torque wrench set to 48-50 pound*inch for unified clamping.
9. Keep regular check at the carbide inserts every day. Replace the broken inserts immediately, otherwise the cutterhead will not balance and the broken inserts are dangerous to your safety and may damage your work.
10. Check the screws regularly and make sure all of them are tight.

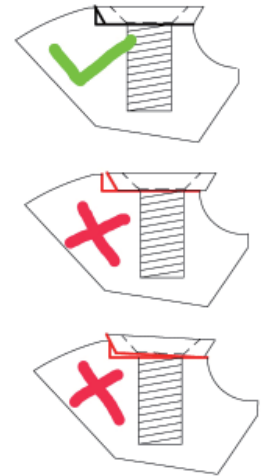

Fig. 4- insert installation

Replace the carbide insert (s) only when four edges are dull or damaged.

For the following machines:

- * Wood planer
- * Wood jointer
- * Wood planer/sander
- * Wood planer/thicknesser
- * Wood shaving machine
- * XPS foam board surfacing machine

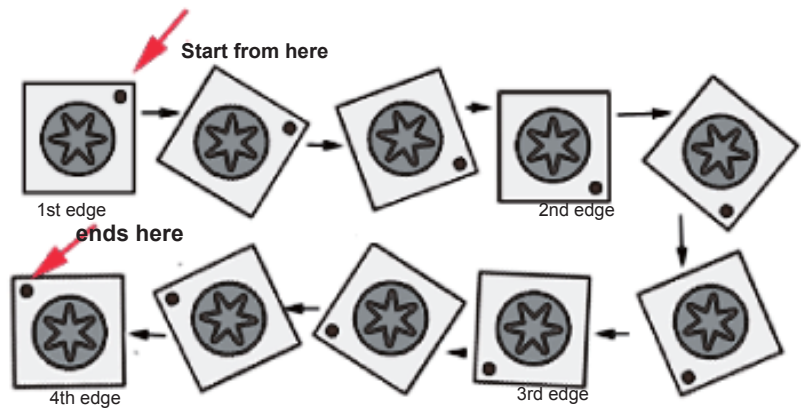

Fig. 3- insert installation

Examples of Applications

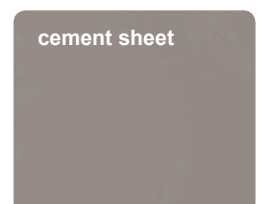
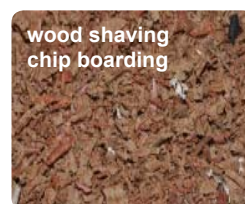
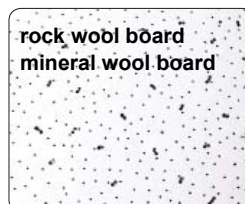
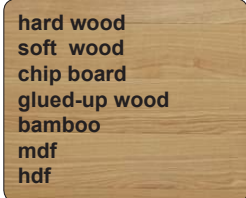

Fig. 5- Application examples

For parts,
email to sales@ctsmanufacturing.com
or fax to +86-532-83517318.

Please provide part descriptions and Cat. Nos. as shown in the table below.

Pictures	Cat. No.	Description
	807-9010	Carbide Insert 15x15x2.5mm R150
	807-9800	T25 Torx Screw 10#-32tpi
	807-9801	T20 Torx screw M6x15
	807-9900	T25 Torx wrench
	807-9901	T20 Torx wrench
	807-9902	T25 Torx wrench

Useful Information

1. Shear cut spiral cutterhead planes only a fraction of the insert edge length while other type of cutterhead cuts the whole length of the cutter edge observed when the cutting speed is slow enough. This technology makes the shear cut spiral cutterhead better than other types.
2. Cutterhead of same maker with more spirals and inserts generates more cut per minute than the cutterhead with fewer spirals and inserts. Consequently cutterhead with more spirals and inserts is better and usually more expensive than the one with fewer spirals and inserts.
3. Eventhough spiral cutterheads has unbeatable advantages over other types of cutterhead, sanding is necessary to achieve glossy surface finish.
4. Spindle speed, feeding speed and the thickness of cut varies with materials. Try to cut a few pieces before production in quantities.
5. Follow your machine manufacturer's instructions about the materials to cut.
6. Excessive snipe or gouge in either end of the board is due to the improper setting of the pressure roller of your machine. Either adjust the height or hardness of the pressure roller or the height of the cutterhead. Note: a small amount of snipe is inevitable. Try to minimize it as much as you like.
7. Nicked, chipped or unevenly installed carbide inserts generate raised lines, ridges or high spots on workpieces. Rotate or replace the carbide insert(s).
8. Inspect the carbide insert edges regularly. If the cutting surface is rough or not as good as before, rotate all the carbide inserts to new edges.

We provide OEM services. Please fill out the sheet below. We will design and make the cutterheads which fit your machines.

OEM Size Sheet

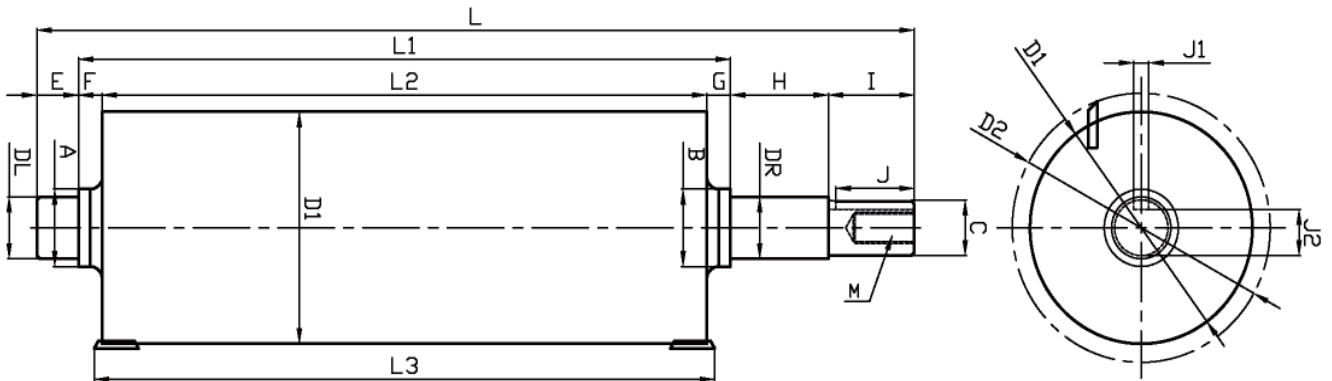

L (overall length)=	F=
L1 (length between bearings)=	G=
L2 (cutter block length)=	H=
L3 (blade or cutting length)=	J (Keyway length) =
A=	J1 (keyway width)=
B=	J2 (From Keyway bottom to shaft) =
DL(Bearing Model No.)=	J3 (Key size) =
DR(Bearing Model No.)=	M (internal thread)=
C=	External thread=
D1 (cutting diameter with blade)=	I=
D2 (Steel block diameter)=	Wings or Nos. of helicals=
E=	Feed rate=
Rotation Dirction seen from the end with pulley to the other end	Clockwise <input type="checkbox"/> Counterclockwise <input type="checkbox"/>
Additional information:	

Company Name	
Client Name	
Phone	
Fax	
Email	
Machine Manufacturer	
Model No.	
Jointer <input type="checkbox"/> Planer <input type="checkbox"/> Planer/Thicknesser <input type="checkbox"/> Plander/Sander <input type="checkbox"/>	